



## Embrace The Future With Ultrasonic Water Meter Technology



Application Standards

# LXC-15G-40G

## Application

Ultrasonic water meter designed for measuring of cold water(T50) and hot water (T90) consumption in households, blocks of flats and for industrial applications.

- M-BUS/RS485 Protocol: *EN13757*
- Modbus Baud Option: *2400 or 9600*
- Pulse Option: *1L/Pulse or 10L/Pulse*
- LoRa/LoRaWAN Frequency Rate:  
*868MHz, 915MHz, 902MHz, 920MHz, etc*

## Communication

M-Bus	RS485	NB-IoT
PULSE	LoRa	LoRaWAN



## Feature Highlights

- |                           |                        |                          |
|---------------------------|------------------------|--------------------------|
| Max battery life 15 years | Exceptional IP68 proof | Install in any position  |
| No air measuring          | Detecting pipe leaks   | The unique patent design |

## Dimensions

Nominal Diameter (mm)	DN15	DN20	DN25	DN32	DN40
Thread	G3/4B	G1B	G1 1/4B	G1 1/2B	G2B
L (mm)	165	195	225	180	200
H (mm)	85	90	95	115	125
W (mm)	85	85	85	85	85

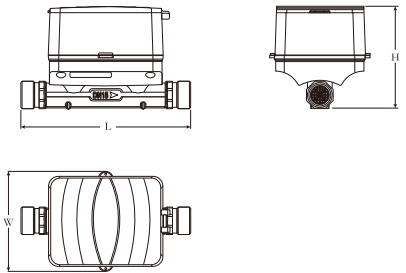

## Error Curve

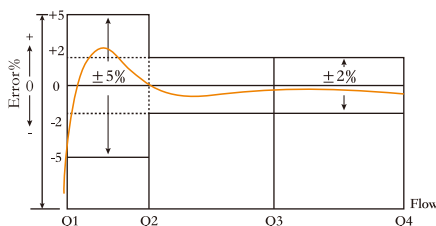

## Head Loss Curve

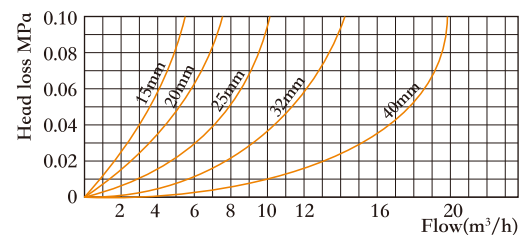

 **Main Technical Specifications**

	DN15	DN20	DN25	DN32	DN40
Q <sub>4</sub> (Q <sub>overflow</sub> )m <sup>3</sup> /h	3.125	5	7.875	12.5	20
Q <sub>3</sub> (Q <sub>max/permanent</sub> )m <sup>3</sup> /h	2.5	4	6.3	10	16
Q <sub>2</sub> (Q <sub>transitional</sub> )m <sup>3</sup> /h	0.01	0.016	0.0252	0.064	0.1024
Q <sub>1</sub> (Q <sub>min</sub> )m <sup>3</sup> /h	0.00625	0.01	0.01575	0.04	0.064
Start Flow Rate m <sup>3</sup> /h	0.002	0.002	0.003	0.005	0.005
Dynamic Range	R400		R250		
Standard	ISO4064 / OIML R49				
Measured Medium	Water				
Metrological Class	Class 2				
Battery	3.6V, Li-battery ER26500(Default) / ER34615				
Battery Life	≥10 Years				
Consumption	<0.2mW				
Pressure Loss	DN15-DN25: Δp40		DN32-DN40: Δp63		
EMC	E1				
Environmental Classification	Class B				
Protection Class	IP68				
Medium Temperature	T50/T90				
Storage Temperature	-25~55°C				
MAP	PN16				
Accuracy	±5% in range Q <sub>1</sub> ≤Q<Q <sub>2</sub> ±2% in range Q <sub>2</sub> ≤Q≤Q <sub>4</sub>				
Material	Brass 59-1				
The Installation Sensivity	U0/D0				
Climatic and Mechanical Environmental Grades	M1				
Key-press	Touch control technology				
Display	LCD 9 digit + prompt				
Menu Contents	Instantaneous flow (m <sup>3</sup> /h), cumulative flow (m <sup>3</sup> ), full screen display, meter address, cumulative working time (h), date (year/month/day), caliber, software version				
Display Range	Total flow :0m <sup>3</sup> ~+99999.9999m <sup>3</sup>				
Communication	Optical Port, M-bus, RS485, Pulse output, LoRa, LoRaWAN, NB-IoT				
Display and Indication	Unit: L/m <sup>3</sup> /Gal (optional)				
Data Storage	84 months				

 **Installation Position**

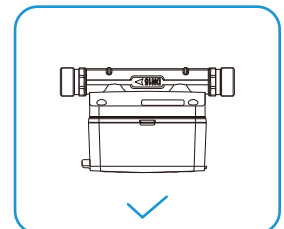
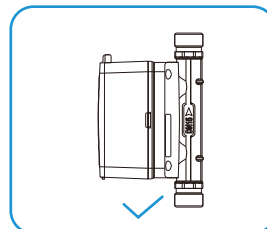
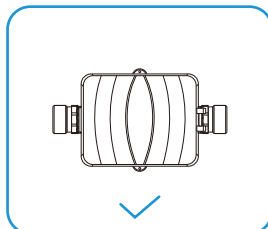
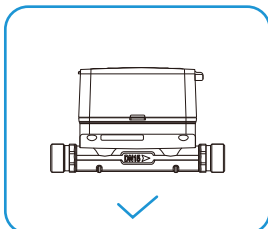



## Built on Innovation For Water Saving



Application Standards

# LXC-15E-20E

## Application

LXC-15E-20E designed for remote control water supply requirement for households, blocks of flats and for industrial by brass valve inbuilt shut off and open.

- M-BUS/RS485 Protocol: *EN13757*
- Modbus Baud Option: *2400 or 9600*
- LoRa/LoRaWAN Frequency Rate: *868MHz, 915MHz, 902MHz, 920MHz, etc*

## Communication



## Feature Highlights

- Max battery life 15 years
- Exceptional IP68 proof
- Install in any position
- No air measuring
- Detecting pipe leaks
- Valve shut off control function

## Dimensions

Nominal Diameter (mm)	DN15	DN20
Thread	G3/4B	G1B
L (mm)	165	195
H (mm)	98.2	98.2
W (mm)	102	102

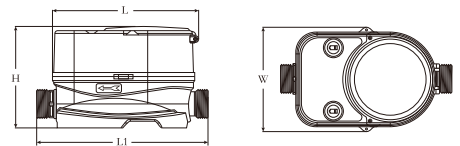

## Error Curve

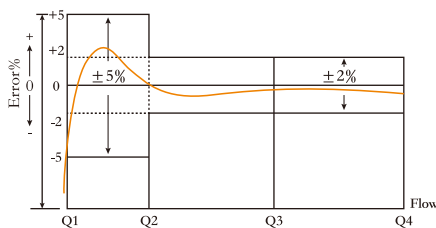

## Head Loss Curve

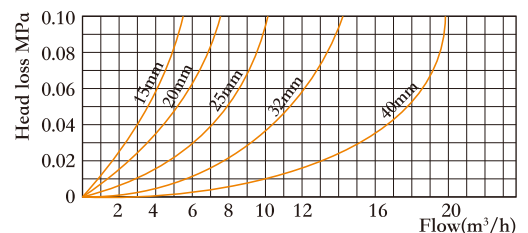

 **Main Technical Specifications**

	DN15	DN20
Q <sub>4</sub> (Q <sub>overload</sub> )m <sup>3</sup> /h	3.125	5
Q <sub>3</sub> (Q <sub>max/permanent</sub> )m <sup>3</sup> /h	2.5	4
Q <sub>2</sub> (Q <sub>transitional</sub> )m <sup>3</sup> /h	0.016	0.0256
Q <sub>1</sub> (Q <sub>min</sub> )m <sup>3</sup> /h	0.010	0.016
Start Flow Rate m <sup>3</sup> /h	0.002	0.002
Dynamic Range	R250	
Standard	ISO4064 / OIML R49	
Measured Medium	Water	
Metrological Class	Class 2	
Battery	3.6V, Li-battery ER26500(Default) / ER34615	
Battery Life	≥10 Years	
Consumption	<0.2mW	
Pressure Loss	Δp40	
EMC	E1	
Environmental Classification	Class B	
Protection Class	IP68	
Medium Temperature	T30/T50	
Storage Temperature	-25~55°C	
MAP	PN16	
Accuracy	±5% in range Q1≤Q<Q2 ±2% in range Q2≤Q≤Q4	
Material	Brass 59-1	
The Installation Sensivity	U5/D3	
Climatic and Mechanical	M1	
Key-press	Touch control technology	
Display	LCD 8 digit + prompt	
Menu Contents	Instantaneous flow (m <sup>3</sup> /h), cumulative flow (m <sup>3</sup> ), full screen display, meter address, cumulative working time (h), date (year/month/day), caliber, software version	
Display Range	Total flow :0m <sup>3</sup> ~+99999.999m <sup>3</sup>	
Communication	Optical Port, M-bus, RS485, LoRa, LoRaWAN, NB-IoT	
Display and Indication	Unit: L/m <sup>3</sup> /Gal (optional)	
Data Storage	84 months	

 **Installation Position**

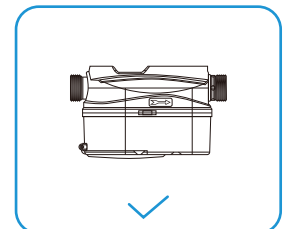
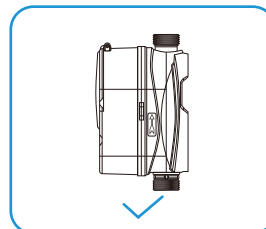
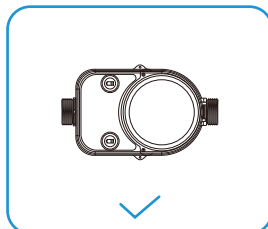
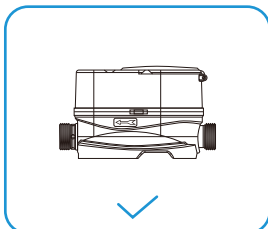



## Embrace The Future With Ultrasonic Water Meter Technology



Application Standards

# LXC-15B-25B

## Application

LXC-15B-25B is an exceptional reliability with IP 68. Its body is fabricated from durable PA66 composite with lead free environmental friendly.

- M-BUS/RS485 Protocol: *EN13757*
- Modbus Baud Option: *2400 or 9600*
- Pulse Option: *1L/Pulse or 10L/Pulse*
- LoRa/LoRaWAN Frequency Rate:  
*868MHz, 915MHz, 902MHz, 920MHz, etc*

## Communication



## Feature Highlights

- Max battery life 15 years
- Exceptional IP68 proof
- Install in any position
- Lead free, RoHS
- Detecting pipe leaks
- UV, moisture resistant

## Dimensions

Nominal Diameter (mm)	DN15	DN20	DN25
Thread	G3/4B	G1B	G1 1/4B
L (mm)	110	130	160
H (mm)	80	85	90
W (mm)	85	85	85

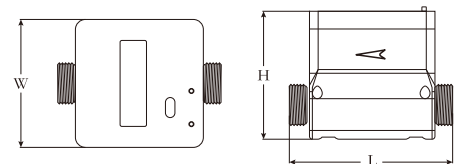

## Error Curve

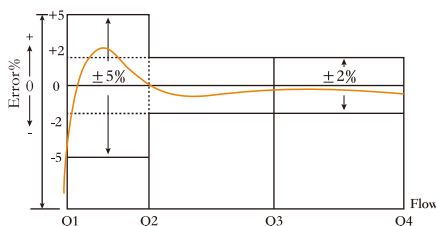

## Head Loss Curve

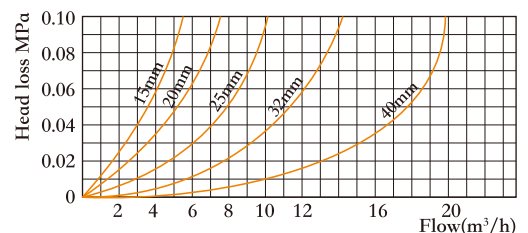



 **Main Technical Specifications**

	DN15	DN20	DN25
Q <sub>4</sub> (Q <sub>overload</sub> )m <sup>3</sup> /h	3.125	5	7.875
Q <sub>3</sub> (Q <sub>max/permanent</sub> )m <sup>3</sup> /h	2.5	4	6.3
Q <sub>2</sub> (Q <sub>transitional</sub> )m <sup>3</sup> /h	0.016	0.0256	0.040
Q <sub>1</sub> (Q <sub>min</sub> )m <sup>3</sup> /h	0.010	0.016	0.0252
Start Flow Rate m <sup>3</sup> /h	0.003	0.005	0.005
Dynamic Range	R250		
Standard	ISO4064 / OIML R49		
Measured Medium	Water		
Metrological Class	Class 2		
Battery	3.6V, Li-battery ER26500(Default) / ER34615		
Battery Life	≥10 Years		
Consumption	<0.2mW		
Pressure Loss	Δp40		
EMC	E1		
Environmental Classification	Class B		
Protection Class	IP68		
Medium Temperature	T50/T90		
Storage Temperature	-25~55°C		
MAP	PN16		
Accuracy	±5% in range Q1≤Q<Q2 ±2% in range Q2≤Q≤Q4		
Material	Composite Material		
The Installation Sensivity	U0/D0		
Climatic and Mechanical	M1		
Key-press	Touch control technology		
Display	LCD 9 digit + prompt		
Menu Contents	Instantaneous flow (m <sup>3</sup> /h), cumulative flow (m <sup>3</sup> ), full screen display, meter address, cumulative working time (h), date (year/month/day), caliber, software version		
Display Range	Total flow :0m <sup>3</sup> ~+99999.9999m <sup>3</sup>		
Communication	Optical Port, M-bus, RS485, Pulse output, LoRa, LoRaWAN, NB-IoT		
Display and Indication	Unit: L/m <sup>3</sup> /Gal (optional)		
Data Storage	84 months		

 **Installation Position**

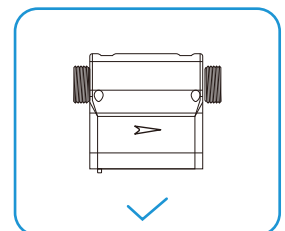
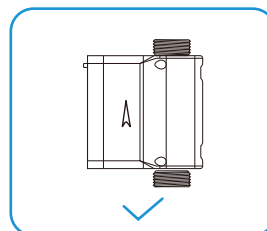
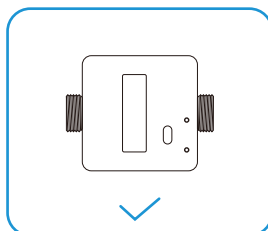
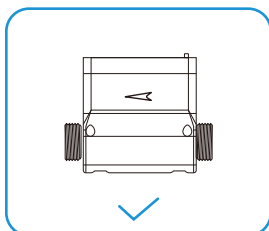



## Embrace The Future With Ultrasonic Water Meter Technology



Application Standards

# LXC-15F-40F

## Application

LXC-15F-40F designed for measuring of cold water(T50) and hot water (T90) consumption in households, blocks of flats and for industrial applications.

- M-BUS/RS485 Protocol: *EN13757*
- Modbus Baud Option: *2400 or 9600*
- Pulse Option: *1L/Pulse or 10L/Pulse*
- LoRa/LoRaWAN Frequency Rate: *868MHz, 915MHz, 902MHz, 920MHz, etc*

## Communication



## Feature Highlights

- Max battery life 15 years
- Exceptional IP68 proof
- Install in any position
- No air measuring
- Detecting pipe leaks
- Battery replacement externally

## Dimensions

Nominal Diameter (mm)	DN15	DN20	DN25	DN32	DN40
Thread	G3/4B	G1B	G1 1/4B	G1 1/2B	G2B
L (mm)	110	130	160	180	200
H (mm)	102	110	120	125	130
W (mm)	95	95	95	95	95

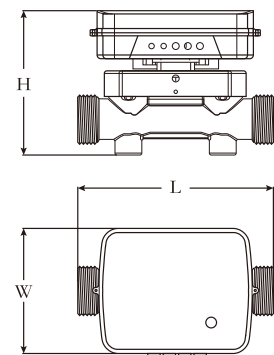

## Error Curve

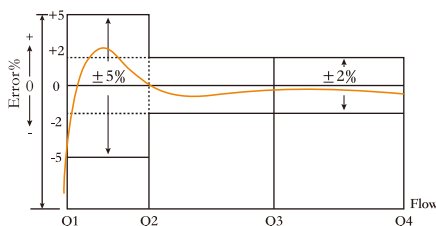

## Head Loss Curve

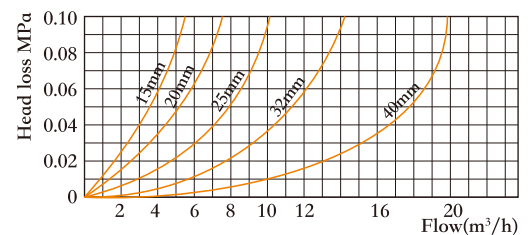

## Main Technical Specifications

	DN15	DN20	DN25	DN32	DN40
Q <sub>4</sub> (Q <sub>overflow</sub> )m <sup>3</sup> /h	3.125	5	7.875	12.5	20
Q <sub>3</sub> (Q <sub>max/permanent</sub> )m <sup>3</sup> /h	2.5	4	6.3	10	16
Q <sub>2</sub> (Q <sub>transitional</sub> )m <sup>3</sup> /h	0.025	0.04	0.063	0.1	0.16
Q <sub>1</sub> (Q <sub>min</sub> )m <sup>3</sup> /h	0.015625	0.025	0.039375	0.0625	0.1
Start Flow Rate m <sup>3</sup> /h	0.002	0.002	0.003	0.005	0.005
Dynamic Range	R160				
Standard	ISO4064 / OIML R49				
Measured Medium	Water				
Metrological Class	Class 2				
Battery	3.6V, Li-battery ER26500(Default) / ER34615				
Battery Life	≥10 Years				
Consumption	<0.2mW				
Pressure Loss	Δp25				
EMC	E1				
Environmental Classification	Class B				
Protection Class	IP68				
Medium Temperature	T50/T90				
Storage Temperature	-25~55°C				
MAP	PN16				
Accuracy	±5% in range Q1≤Q<Q2 ±2% in range Q2≤Q≤Q4				
Material	Brass 59-1				
The Installation Sensivity	U5/D3				
Climatic and Mechanical	M1				
Key-press	Touch control technology				
Display	LCD 9 digit + prompt				
Menu Contents	Instantaneous flow (m <sup>3</sup> /h), cumulative flow (m <sup>3</sup> ), full screen display, meter address, cumulative working time (h), date (year/month/day), caliber, software version				
Display Range	Total flow :0m <sup>3</sup> ~+99999.9999m <sup>3</sup>				
Communication	Optical Port, M-bus, RS485, Pulse output, LoRa, LoRaWAN, NB-IoT				
Display and Indication	Unit: L/m <sup>3</sup> /Gal (optional)				
Data Storage	84 months				

## Installation Position

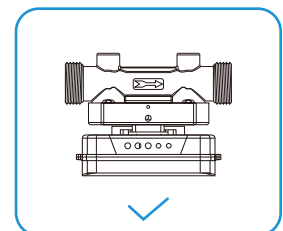
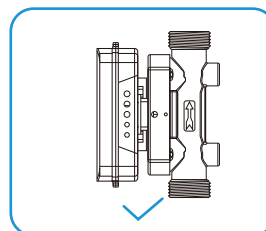
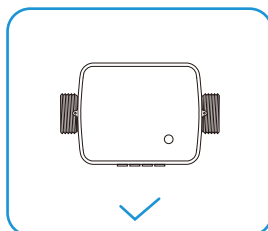
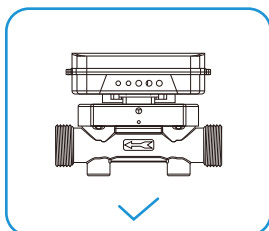



## Embrace The Future With Ultrasonic Water Meter Technology



Application Standards

# LXC-50H-500H

## Application

A revolutionary, precise and ultra reliable ultrasonic bulk water meter applied to Utilities, Waterworks, Industrial and Agricultural applications.

- M-BUS/RS485 Protocol: *EN13757*
- Modbus Baud Option: *2400 or 9600*
- Pulse Option: *100L/Pulse or 1000L/Pulse*
- LoRa/LoRaWAN Frequency Rate: *868MHz, 915MHz, 902MHz, 920MHz, etc*

## Communication

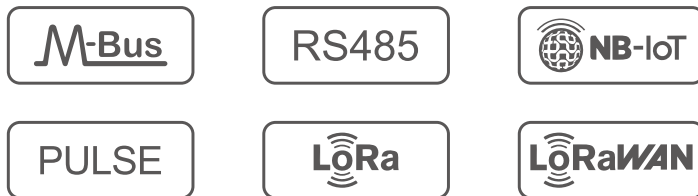

## Feature Highlights

- Max battery life 15 years
- Exceptional IP68 proof
- Reliable operation in harsh environments
- Install indoor and outdoor available
- Installed on main pipe
- Low friction sensibility and high durability time

## Dimensions

Nominal Diameter	L(mm)	H(mm)	W(mm)	Md	Bolt Hole Qty
DN50	200	220	170	M16	4
DN65	200	240	185	M16	4
DN80	225	255	250	M16	8
DN100	250	275	270	M16	8
DN125	250	305	300	M16	8
DN150	300	335	330	M20	8
DN200	350	395	380	M20	12
DN250	450	460	415	M24	12
DN300	500	510	470	M24	12
DN350	550	560	520	M24	16
DN400	600	590	580	M27	16
DN450	650	620	640	M27	20
DN500	650	650	705	M30	20

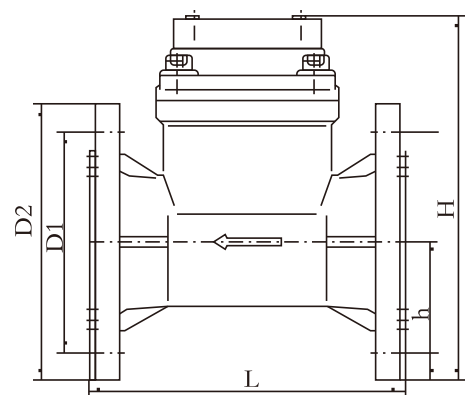

**Main Technical Specifications**

Diameter	Permanent Q3 (m³/h)	Transitional Q2 (m³/h)	Minimum Q1 (m³/h)	Overload Q4 (m³/h)
DN50	25	0.25	0.15625	31.25
DN65	40	0.4	0.25	50
DN80	63	0.63	0.39375	78.75
DN100	100	1	0.625	125
DN125	160	1.6	1	200
DN150	250	2.5	1.5625	312.5
DN200	400	4	2.5	500
DN250	630	6.3	3.9375	787.5
DN300	1000	10	6.25	1250
DN350	1400	17.9	11.2	1750
DN400	1600	20.5	12.8	2000
DN450	2000	25.6	16	2500
DN500	2500	32	20	3125
Accuracy Class	Class 2			
Range Ratio	R160			
Pressure Loss	Δp40			
Maximum Working Pressure (MPa)	1.6			
Data Storage	Data storage for continual 84 months			
Power-off Protection	The data of accumulated flow and corresponding time will be saved once power failure takes place, and the meter works automatically as soon as the power restoration			
Remote Transmission	Optical Port, M-bus, RS485, Pulse output, LoRa, LoRaWAN, NB-IoT			
Power Supply	Lithium Battery Power Supply			
Protection Class	IP68			
Medium Temperature Range	0.1°C...30°C / 0.1°C...50°C / 0.1°C...90°C			
Ambient Temperature Range	-20°C...55°C			
Environment	E1, M1, B			
Flow Field Sensitivity	DN50-DN200: U5/D3    DN250-DN500: U10/D5			
Installation	Horizontal or Vertical			
Service Life	Life Time≥10 years			

**Installation Position**

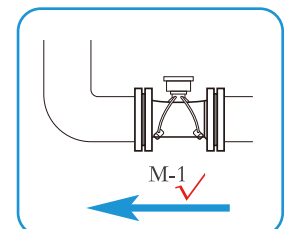
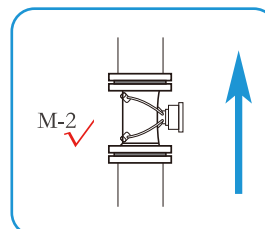
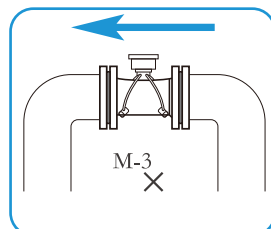
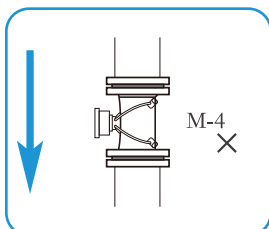



## Embrace The Future With Ultrasonic Water Meter Technology



Application Standards



# LXC-50M-500M

## Application

A revolutionary, precise and ultra reliable ultrasonic bulk water meter applied to Utilities, Waterworks, Industrial and Agricultural applications.

- M-BUS/RS485 Protocol: *EN13757*
- Modbus Baud Option: *2400 or 9600*
- Pulse Option: *100L/Pulse or 1000L/Pulse*
- LoRa/LoRaWAN Frequency Rate: *868MHz, 915MHz, 902MHz, 920MHz, etc*

## Communication

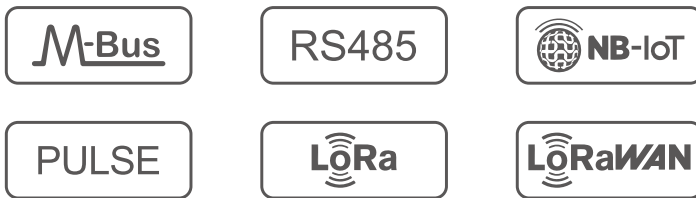

## Feature Highlights

- Max battery life 15 years
- Exceptional IP68 proof
- Reliable operation in harsh environments
- Install indoor and outdoor available
- Installed on main pipe
- Low friction sensibility and high durability time

## Dimensions

Nominal Diameter	L(mm)	H(mm)	W(mm)	Md	Bolt Hole Qty
DN50	200	220	170	M16	4
DN65	200	240	185	M16	4
DN80	225	255	250	M16	8
DN100	250	275	270	M16	8
DN125	250	305	300	M16	8
DN150	300	335	330	M20	8
DN200	350	395	380	M20	12
DN250	450	460	415	M24	12
DN300	500	510	470	M24	12
DN350	550	560	520	M24	16
DN400	600	590	580	M27	16
DN450	650	620	640	M27	20
DN500	650	650	705	M30	20

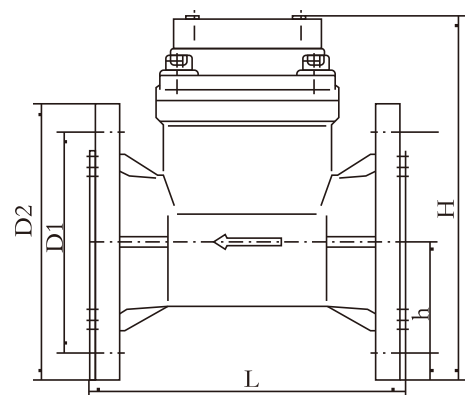

**Main Technical Specifications**

Diameter	Permanent Q3 (m³/h)	Transitional Q2 (m³/h)	Minimum Q1 (m³/h)	Overload Q4 (m³/h)
DN50	25	0.25	0.15625	31.25
DN65	40	0.4	0.25	50
DN80	63	0.63	0.39375	78.75
DN100	100	1	0.625	125
DN125	160	1.6	1	200
DN150	250	2.5	1.5625	312.5
DN200	400	4	2.5	500
DN250	630	6.3	3.9375	787.5
DN300	1000	10	6.25	1250
DN350	1400	17.9	11.2	1750
DN400	1600	20.5	12.8	2000
DN450	2000	25.6	16	2500
DN500	2500	32	20	3125
Accuracy Class	Class 2			
Range Ratio	R160			
Pressure Loss	Δp40			
Maximum Working Pressure (MPa)	1.6			
Data Storage	Data storage for continual 84 months			
Power-off Protection	The data of accumulated flow and corresponding time will be saved once power failure takes place, and the meter works automatically as soon as the power restoration			
Remote Transmission	Optical Port, M-bus, RS485, Pulse output, LoRa, LoRaWAN, NB-IoT			
Power Supply	Lithium Battery Power Supply			
Protection Class	IP68			
Medium Temperature Range	0.1°C...30°C / 0.1°C...50°C / 0.1°C...90°C			
Ambient Temperature Range	-20°C...55°C			
Environment	E1, M1, B			
Flow Field Sensitivity	DN50-DN200: U5/D3    DN250-DN500: U10/D5			
Installation	Horizontal or Vertical			
Service Life	Life Time≥10 years			

**Installation Position**

